



SP209 Series

9-Channels, 200MSPS logic analyzer

Product status: Active.

01.FEB.2019

PRODUCT DATA SHEET



IKALOGIC S.A.S.
19 Rue Columbia
87000 Limoges
FRANCE

Table of contents

Table of contents	1
SP209 Series overview	2
Typical applications	2
Product highlights	2
Main characteristics	3
SP209(i) Interfaces	3
Principle of operation	4
Embedded memory vs streaming	4
Versatile trigger system	4
External trigger OUT specifications	5
External trigger IN specifications	5
Industrial port (SP209i only)	5
What's in the box	6
Unpacking and first usage	6
Status LEDs behavior	6
Software quick start guide	6
Capturing your first signal	7
Mechanical data	7
Model SP209i	7
Model SP209	7
Probes	7
Software technical requirements	8
Ordering information	8
Certifications and regulations	8
Document Revisions	9

SP209 Series overview

SP209 series logic analyzers and protocol decoders offer in depth analysis of logic signals and protocols with 200MHz (5ns) timing resolution. 9-channel operation allows 8-bit parallel data to be captured along with a clock or strobe signal.

SP Series is composed of two devices, SP209 and SP209i. Both offer 9 logic inputs, but SP209i integrates industrial receivers for CAN, LIN, RS232 and RS485 buses¹.

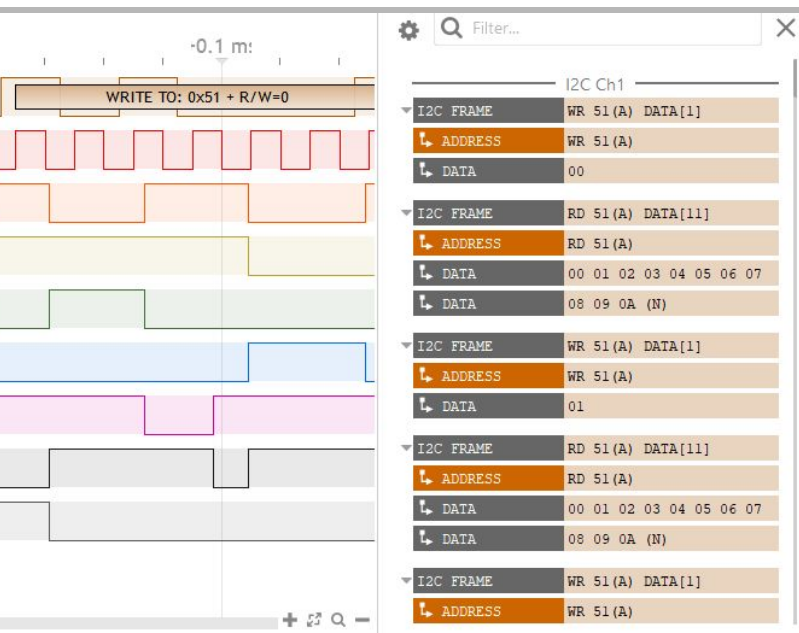

Typical applications

SP series logic analyzers are perfectly adapted for demanding applications, where it is needed to capture logic signals with maximum time resolution on all 9 channels.

- Embedded systems debugging
- Research and education
- Serial protocols analysis, like I2C, SPI, UART or 1-Wire (non exhaustive list)
 - Industrial bus analysis: RS232, RS485, CAN, LIN
 - ADC diagnostic

Product highlights

- Schmitt trigger input stages with adjustable thresholds
- 200 MHz sampling rate, with all 9 channels used.
- External clock option (state mode), up to 50MHz
- Precise trigger-In and trigger-Out signals on SMA ports

¹ Industrial receivers in the SP209i are multiplexed with one or more of the existing 9 logic channels

Main characteristics

Timing and measurements	
Sampling rate (MAX.)	200 MSPS
External clock Max. rate (State mode)	50 MHz
Logic Inputs digital bandwidth	50 MHz
Embedded memory	2 Gb ²
Trigger output	Yes, via SMA connector
External trigger input	Yes, via SMA connector

Logic inputs	
Number of channels	9
Input impedance	200 K Ω 8 pF
Threshold circuits	3
Adjustable logic level (for each threshold)	1.8, 2.5, 3.3, 5V
Absolute max voltage on digital inputs Continuous	± 25 V

Power requirements	
Input power connector	Micro USB female
Input current	500 mA
Input voltage	5 V \pm 0.25 V
Communication interface	USB 2.0 High Speed

² DDR-3 sampling memory is used to buffer samples before streaming to host computer.

SP209(i) Interfaces

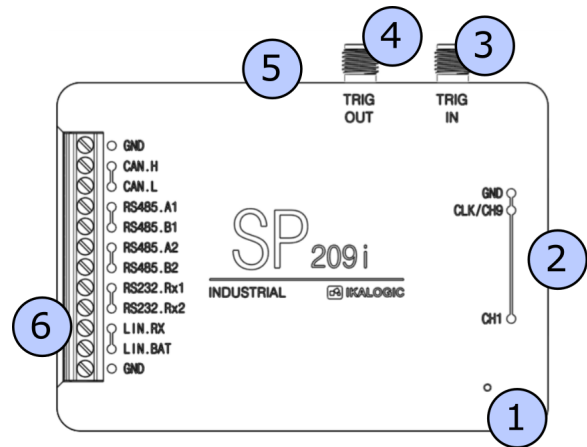

1. Status LED
2. 9-CH logic probes input
3. Trigger OUT SMA connector
4. Trigger IN SMA connector
5. USB (micro-B) port.
6. Industrial port³

Principle of operation

SP209 Series logic analyzers connects to a computer via a USB cable. A free software - called ScanaStudio - is used to configure the device and display captured signals. The software can also be used to further analyze the captured samples by decoding protocols like I2C, SPI or UART.

Embedded memory vs streaming

USB based logic analyzers (ones that don't have a display and rely on a computer for that matter) usually operate according to one of two schemes:

- Using an **embedded memory** to store captured samples. Samples

³ Only on SP209i (industrial) version.

are later downloaded at a slower speed via the USB interface. This has the advantage of not being limited by USB transfer rate, but has the disadvantage of limited embedded memory.

- **Streaming** captured samples over the USB connection, at the maximum possible speed. While this offers the advantage of a virtually unlimited memory (only limited by host computer's memory), it has the disadvantage of limiting the sampling rate to USB's throughput.

SP209 combines the advantages of both streaming and embedded memory techniques. An embedded 2Gb DDR-3 memory stores captured samples at 200 MHz sampling rate on all channels, while a USB interface compresses and transfers the data simultaneously, effectively emptying the embedded memory and making more room for new samples.

This results in a logic analyzer that can capture dozens of minutes of logic signals activity on 9 channels at 200 MSPS.

Versatile trigger system

SP209 series offer a state of the art trigger system. It's composed of two FlexiTrig® trigger engines, each FlexiTrig engine can be used in one of those modes:

- Edge trigger
- Pulse trigger (with minimum and maximum pulse width)
- Timed logic sequence
- Protocol based trigger (e.g. I2C bus address or serial UART character)
- External trigger source

Furthermore, the two trigger engines (called A and B hereafter) can be cascaded in one of the following modes:

- A then B (Wait until A triggers then arm B trigger engine)
- B then A
- A and B (Trigger engines A and B must trigger, but in any order)
- A or B (whoever triggers first)

Finally, an external trigger output is always active, in all modes and generates a trigger pulse whenever a trigger condition is met and a capture starts.

Signal specifications for External trigger input and output are detailed in following section.

External trigger OUT specifications

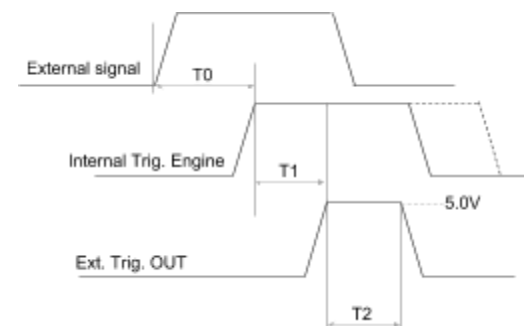

There is an internal data path delay of 20ns before external signals reach internal trigger engine (T0). When trigger event occurs, a 10ms (T2) pulse is generated on the Trig Out port. This port has a 50 Ω series impedance allowing easy interfacing to 50Ω input devices. This can be used to synchronise the capture with other equipment like an oscilloscope. Polarity of the trigger can be set in software. There is also a 10 ns delay (T1) between internal trigger detection and Trig Out assertion. Therefore, the total time for an external event to generate a Trigger OUT pulse is $T0+T1 = 30ns$.

External trigger IN specifications

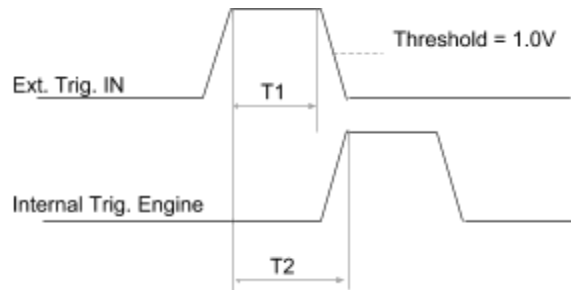

The Trig In port allows to start acquisition on an external event generated by another instrument. The minimum pulse width (T1) is 5ns. Polarity can be set in software. The input impedance is also software selectable (100kΩ or 50Ω). The threshold level is 1.0V. T2, the time between external trigger in active edge and internal trigger engine assertion is 20ns.

Industrial port (SP209i only)

SP209i offer the possibility to connect directly to industrial buses, as opposed to logic channels which can only be connected to single ended logic level such as LVCMOS or LVTTTL. Each one of the industrial inputs integrates a dedicated receiver circuit, perfectly adapted to each standard.

For more reliability in an industrial context, each bus receiver is exposed via screw terminals. Adequate wires (6-30 AWG) should be used to connect SP209i to the the bus being probed⁴.

Industrial receivers offer the advantage of visualizing exactly what a standard

⁴ Wires to connect SP209i to industrial bus are not provided.

off-the-shelf transceiver would receive if connected to that bus.

The list of the industrial inputs is detailed below:

- 1 CAN bus receiver
- 2 RS485 bus receiver (can be combined to form a full duplex RS422 bus receiver)
- 2 RS232 receivers
- 1 LIN bus receiver

Please refer to the SP209i casing for exact pinout.

RS485 receiver specifications	
Max. baudrate	50 Mbps
Common Mode Operating range	-7 V to +12 V
Common Mode Input Impedance	48 kΩ 10 pF (preliminary)
Common Mode voltage abs. max	±15 V
Differential Threshold voltage	-125 mV
Differential Fixed hysteresis	25 mV
Differential Input Impedance	400 kΩ or 120 Ω Software selectable (preliminary)

RS232 receiver specifications	
Max. baudrate	1.5 Mbps
Operating range	±15 V
Input Impedance	5 kΩ 50 pF (preliminary)
Absolute max voltage	±20 V
Threshold voltage	1.5 V
Hysteresis	300 mV

CAN receiver specifications	
Max. baudrate	8 Mbps
Common Mode Operating range	±12 V
Common Mode Input Impedance	T.B.D.
Common Mode Absolute max voltage	±24 V
Differential Mode Operating range	-4 V to +9 V
Differential Threshold voltage	700 mV
Differential Fixed hysteresis	30 mV to 200 mV
Differential Input Impedance	25 kΩ 20 pF or 120 Ω Software selectable (preliminary)

LIN receiver specifications	
Max. baudrate	20 kbps
Operating range (BAT pin)	6 V to 18 V
Operating range (RX pin)	0 V to 18 V
RX pull up resistance (to BAT)	40 kΩ
Absolute max voltage (BAT)	±24 V
Absolute max voltage (RX)	±24 V
Threshold voltage	0.5 * VBAT
Hysteresis	0.12 * VBAT

Please note that SP209i can still only capture 9 channels simultaneously. Industrial inputs are internally multiplexed with logic inputs.

It is recommended to connect the ground of the industrial bus being measured to the nearest ground screw terminal.

What's in the box

SP209 series is shipped with the following accessories:

- SP209(i) device
- 10 leads micro-grabber probes set (premium quality, custom Ikalogic design)
- 1 meter length Micro-USB cable
- Cable comb

Unpacking and first usage

We recommend the user to start by identifying all different components that are provided, then connect the SP209 device to a free USB port of your computer using the provided USB cable. The LED should glow according to the table in the "Status LEDs behavior" section.

Status LEDs behavior

Status led can be in one of 3 states:

Status LED	
Orange	Device powered up but not connected to software
White Fix	Device powered up and connected to software
White blinking	Device powered up, connected to software and detecting activity on one of the logic channels.

Software quick start guide

Start by downloading latest version of ScanaStudio software www.ikalogic.com and following instructions to install both

software and provided drivers. It is recommended to restart your computer after the software and drivers have been installed.

Once the software is installed, run it, and create a new workspace by selecting “SP209” or “SP209i” as the device type.

Note: if at the point the device is not recognised by your computer, the ScanaStudio workspace is created as a demo workspace or the status LEDs stays orange even after creating a ScanaStudio workspace, please follow those steps:

- Ensure the USB port used can deliver at least 500mA.
- Try switching to another machine if one is available.
- If all the above fails, please contact Ikalogic support.

Capturing your first signal

To capture your first logic signals, please follow those steps:

1. Connect the device via USB
2. Launch ScanaStudio and create an SP209(i) workspace.
3. Connect the probes to SP209(i) and to your signals source
4. Ensure the ground probe is connected
5. Check if the status LED is blinking: if it's the case, it means the some logic changes are already being detected on the probes.
6. Hit the start button in ScanaStudio and wait until signals are captured.

You can adjust the quantity of samples to capture by adjusting the number of samples in the device configuration tab.

Mechanical data

All SP209 series devices casing are manufactured from anodized aluminum, able to withstand heavy duty usage in various harsh environments. All markings are laser engraved, ensuring important pinout information is not lost over time.

Model SP209i

Weight: 105 gm

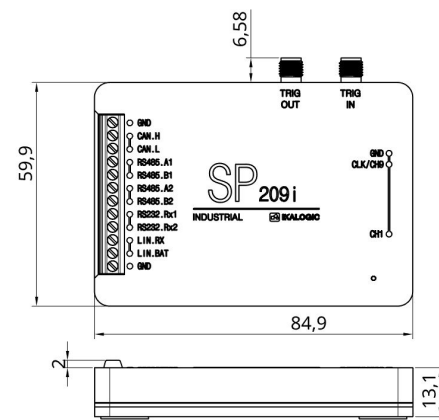

(All dimensions in mm)

Model SP209

Weight: 90 gm (preliminary)

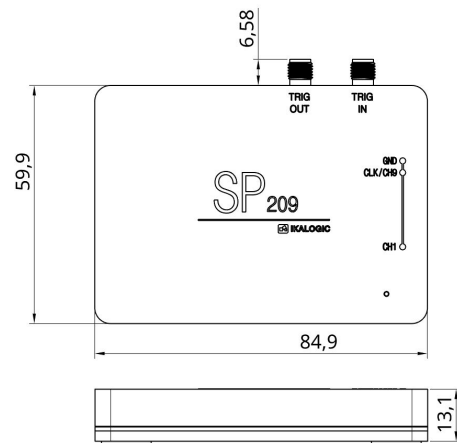

(All dimensions in mm)

Probes

Probes cables are made of 24AWG extra flexible silicone wires. All wires are black colored, but every wire has a white marking tube with the channel number (e.g. "1" or "GND") and a colored sticker on the probe tip.

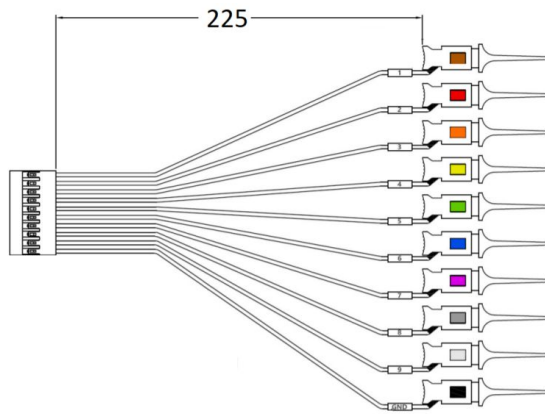

(All dimensions in mm)

Software technical requirements

Download ScanaStudio software on www.ikalogic.com so you can use your device on your favorite platform.

SP209(i) and ScanaStudio were tested to supports the following platforms:

- Windows 7/8/10
- Mac OS 10.9 or later
- Ubuntu 14.04 or later

Ordering information

For ordering information, please check for nearest distributor on www.ikalogic.com

or contact us for any inquiry at contact@ikalogic.com.

Certifications and regulations

This device complies with the following applicable European Directives: Electromagnetic Compatibility (EMC) Directive 2004/108/EC, Low-Voltage Directive 2006/95/EC, IEC61326-2.

This device complies with part 15 of the FCC Rules. Operation is subject to the following two conditions: (1) This device may not cause harmful interference, and (2) this device must accept any interference received, including interference that may cause undesired operation.

CAN ICES-3 (B) / NMB-3 (B)

RoHS Compliant 2011/65/EC. This device does not contain any of the substances in excess of the maximum concentration values ("MCVs") defined in the EU RoHS Directive.

NOTE: This equipment has been tested and found to comply with the limits for a Class B digital device, pursuant to part 15 of the FCC Rules. These limits are designed to provide reasonable protection against harmful interference in a residential installation. This equipment generates uses and can radiate radio frequency energy and, if not installed and used in accordance with the instruction, may cause harmful interference to radio communications. However, there is no guarantee that interference will not occur in a particular installation. If this equipment does cause harmful interference to radio or television reception which can be determined by turning the equipment off and on, the user is encouraged to try to correct interference by one or more of the following measures:

- Reorient or relocate the receiving antenna.
- Increase the separation between the equipment and receiver.
- Connect the equipment into an outlet on circuit different from that to which the receiver is connected.
- Consult the dealer or an experienced radio/TV technician for help.



Document Revisions

- 01-February-2019:
 - Moved from preliminary to final release.
 - Fixed spelling error in quick start section
- 22-November-2018:
 - Fixed error in “What’s in the box” chapter.
 - Updated trigger OUT and trigger IN specifications.
 - Updated device weight.
- 10-October-2018: Initial release of this datasheet.

This information is subject to change without notice. © Ikalogic SAS 2018, www.ikalogic.com